

ANEX

High Performance Fixed Stroke Presses

15-150 Tons Capacity

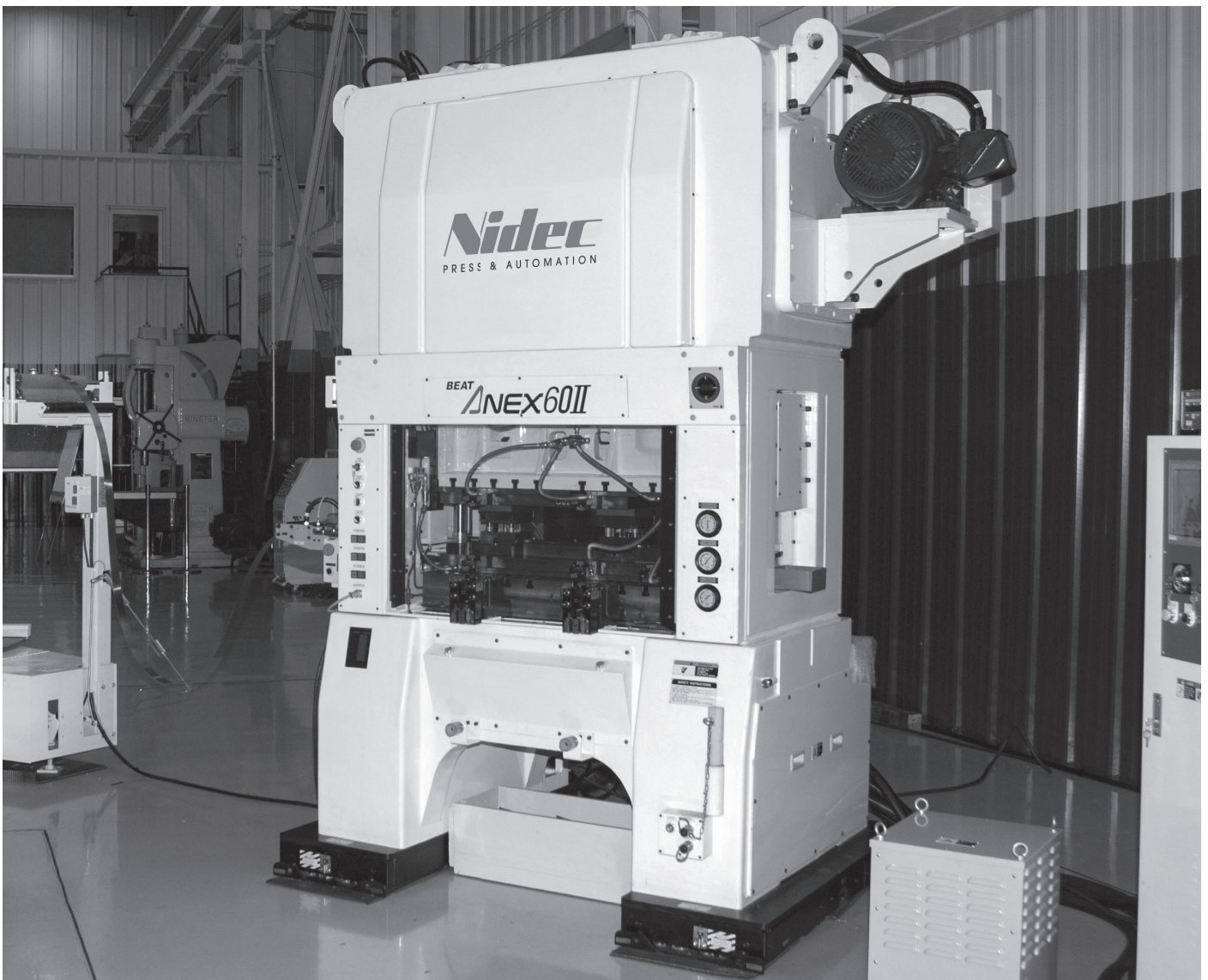

Product Overview

With more than 30 years of expertise in link motion press technology, Kyori's knuckle link presses have earned the reputation for high precision, high performance and ease of operation from users all around the world.



- 1** Consistent accuracy and precision for automated blanking and bending operations.
- 2** Low maintenance costs from the rugged and proven design of more than 4,000 installed presses.

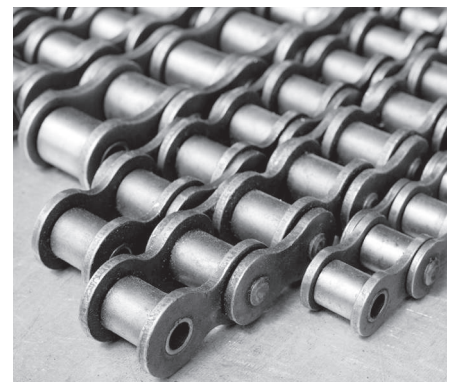
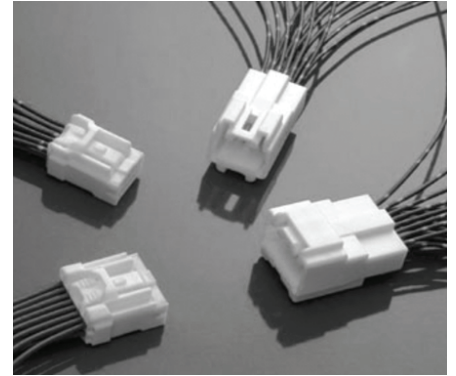
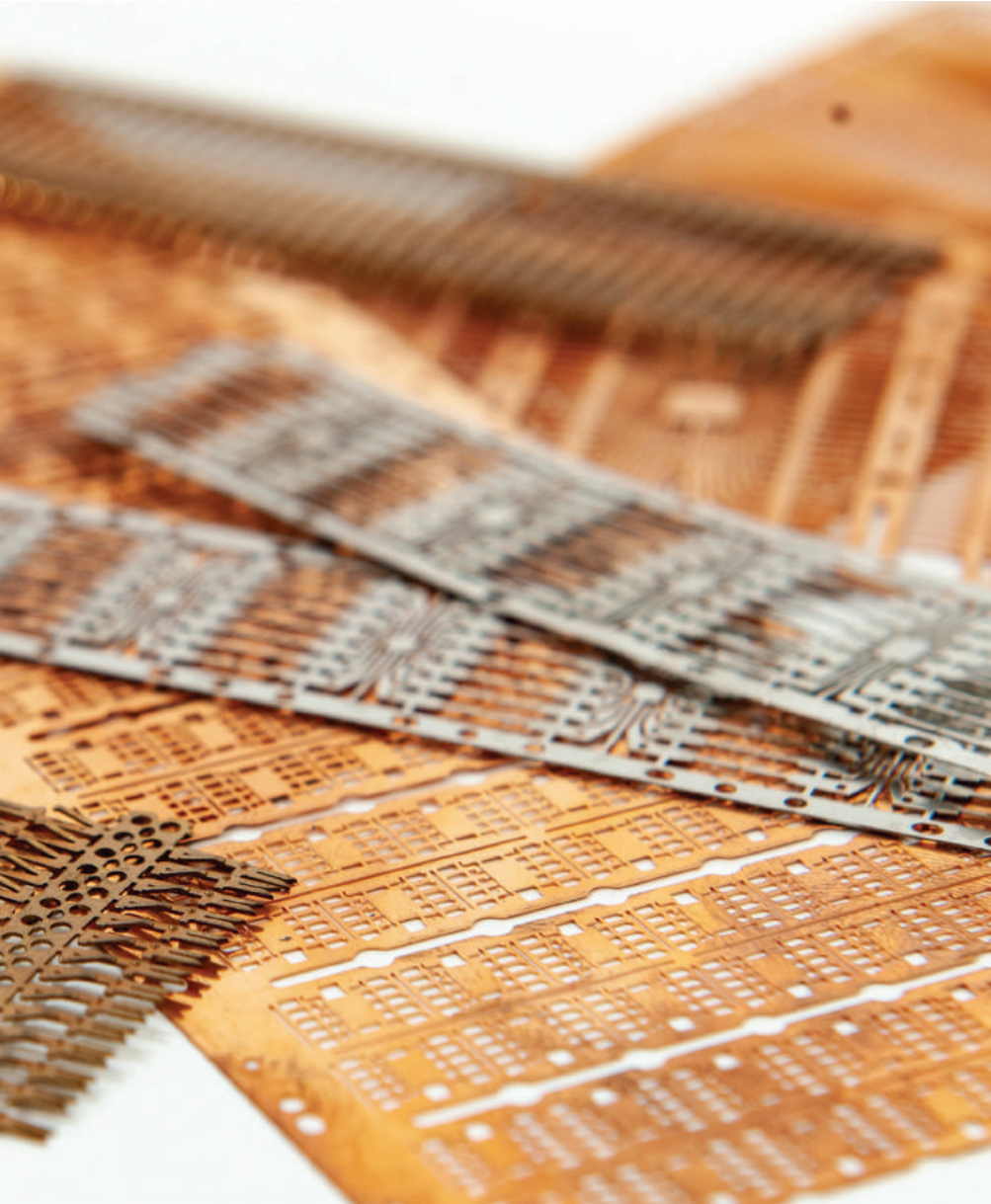

3 Ease of tool set-up and storage from integrated press and feed controls with the Vamco SR series feeds.

5 No need for thermal or dynamic stroke length compensation mechanisms creating less complicated drive mechanism.

4 Increased tool life and part quality from knuckle link motion creating a slower slide movement through bottom-dead-center.

Standard Features

Symmetrical Link Design

The knuckle link design of the ANEX series presses eliminates thermal displacement resulting in precise bottom-dead-center repeatability. In addition, the design contributes to greater durability, longer die life and reduced noise and vibration.

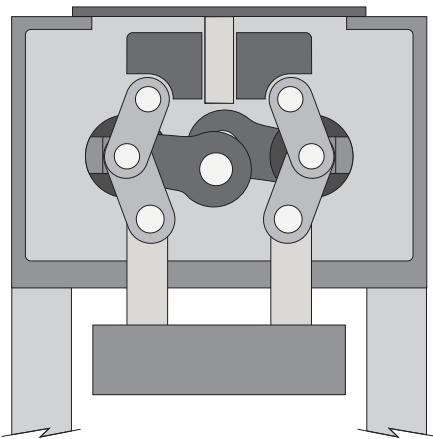

Accurate Slide Guiding

Kyori ANEX presses use 8-point needle bearings for slide guiding as opposed to competitors' post guiding systems. Needle bearings are able to withstand a much larger load and the long guide ways resist off-center loading. The positioning of the guides make them easy to maintain.

Link Slide Motion

The link slide motion allows for more time on the bottom of the stroke for better part forming and reduced impact of snap-thru forces which extends press and die life. The time between re-sharpening of the dies in an ANEX series press is more than 25% greater than that of a conventional crank press.

Slide Motion

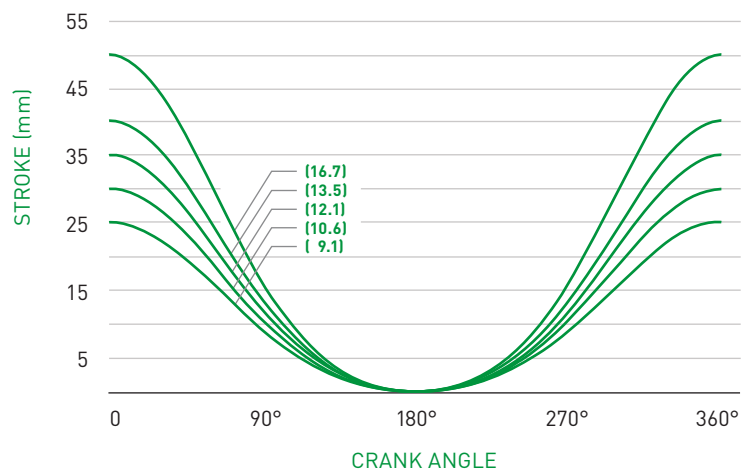

Eight-Point Needle Bearings

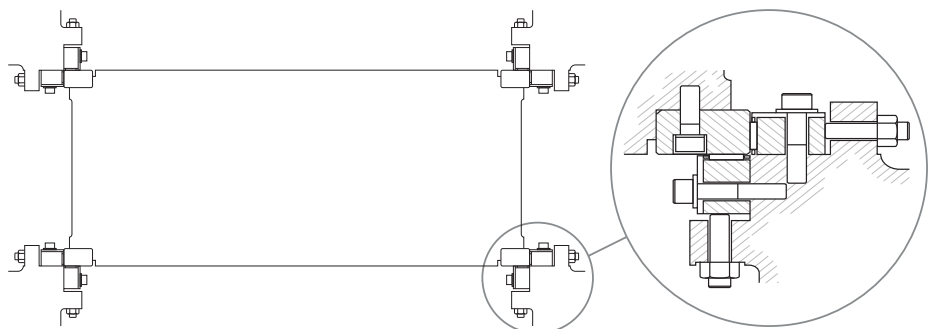

Dynamic Balancer

The dynamic balancer feature allows the press to be operated at full speed with minimal inertial effect. The balancer weight reciprocates as the slide moves downward resulting in perfect balance vertically and horizontally with minimal vibration.

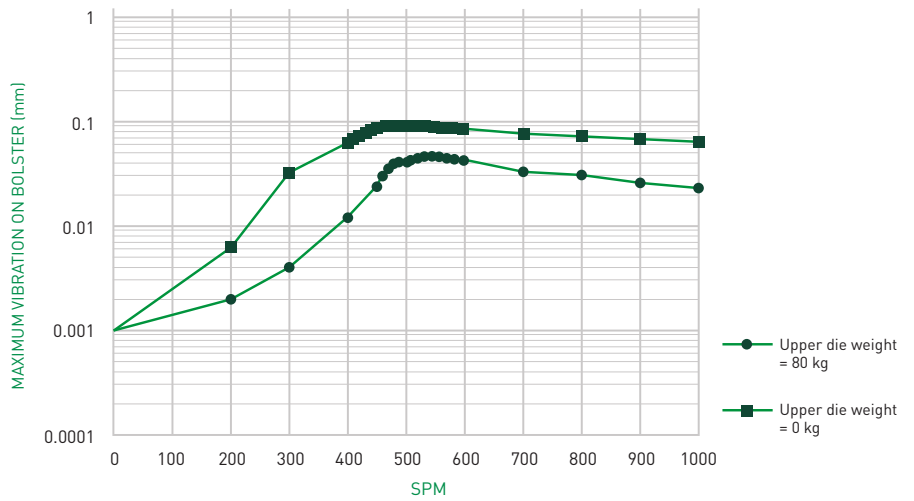

Minimal Shutheight Variation

The extremely simple ANEX knuckle link mechanism consists of large-diameter pins and high-strength links, offering greater rigidity. This high rigidity and precision bearings provide greater bottom-dead-center repeatability.

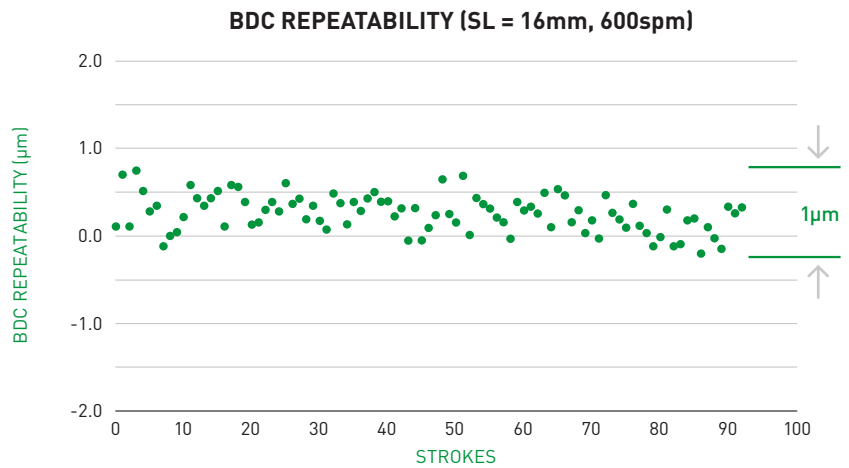

Heat Generation and Thermal Cancellation

In the conventional crank press mechanism, thermal displacement accumulates caused by the heat generated during operation, and results in fluctuating bottom-dead-center significantly. The design of the ANEX link mechanism offsets thermal displacement and minimizes bottom-dead-center fluctuation even in long time operation.

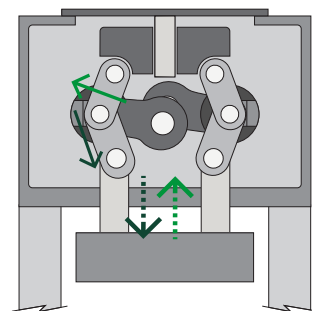
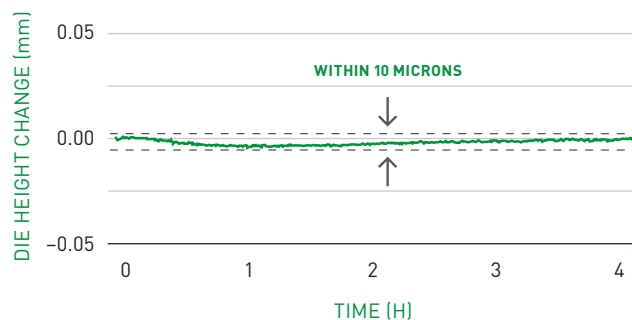

Standard Features

40 Grade Cast Iron Frame Construction

This construction provides the compressive strength and vibration dampening characteristics that provide greater die life and part accuracy. Iron has 2.5 to 4.5 times the dampening capability of steel. Therefore, the ANEX utilizes castings where applicable in its beds, crowns and uprights to dampen vibration and noise created in high vibration and snap-thru applications.

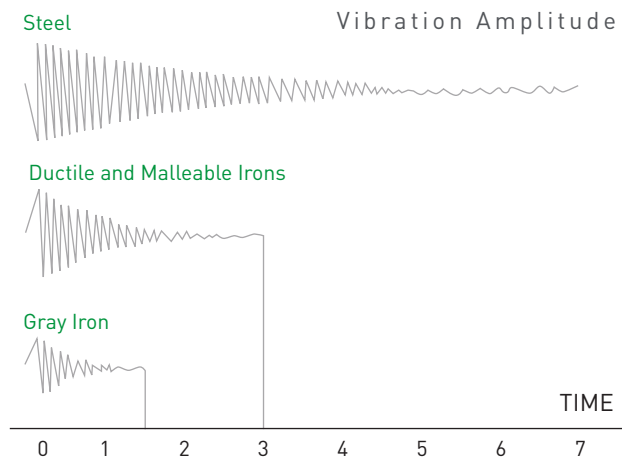

Combination Air Friction Clutch and Brake Unit

One moving member engages the clutch by air pressure or applies the brake by spring pressure. Movement from full brake to complete engagement is approximately 1.59 mm assuring quick, controlled stopping at any speed increasing die life and parts production. Engagement on 360° friction surfaces remains constant throughout the stroke eliminating backlash after stamping and on the upstroke.



Motorized Slide Adjustment

The slide adjustment on the ANEX press is driven by a servo motor and the exact shutheight is displayed on the press console and the repeatability is within 0.01 mm.

Reduced Noise

The reduction of noise is inherent in the construction of the knuckle link mechanism used in Kyori ANEX series presses. The strong shock absorbing bearing structure contributes to the production of less high frequency noise.

Oil Heater/Chiller

To ensure accurate bottom-dead-center repeatability, the unit can be programmed to heat and circulate the oil prior to operation. Once the press is in production mode, the oil is circulated through the chiller to maintain the proper temperature. The temperature is achieved automatically by the press SPM.

Continuous Press Lubrication

The ANEX incorporates a pressurized recirculating oil lubrication system which supplies a continuous flow of filtered oil under pressure to all bearing surfaces ensuring reliable operation.

Main Motor

The inverter-type main drive motor on the ANEX series of presses is variable speed drive providing greater flexibility and higher performance throughout the full speed range, resulting in lower cost to the user.

Die Doors

These standard safety features include pneumatically controlled doors with up and down motion on the front of the press and/or cabinet style doors on the rear.

Micro Inching

Kyori ANEX users can enjoy the feature of full tonnage micro-inching of the press to assist with die set-up and troubleshooting.

Quick Open return

This quick open return function allows die height to move upward automatically at checking die or cleaning, and to return the original position automatically after checking die or cleaning.

Shock Mounts

Isolation/leveling mounts are included as standard equipment on Kyori ANEX series presses.

Additional Standard Features

- End of Stock Detector
- Air Outlet
- Work Lights

Options

Optional Features

- Die Height Detector (4-Channel)
- Air Ejector With DC Solenoid Valve
- Material Holding Cylinder
- Die Clamps (Upper & Lower)
- Die Lift Rails (2 Front, 2 Rear)
- 2-Piece Die Table

Optional Vamco SR Feed Integration

Designed to consistently perform and withstand the vibration of the most severe stamping applications, the SR series is directly mounted to the press and is electronically cammed to the crankshaft ensuring the highest feeding performance.

- Double axis servo feed (feed rolls & pilot release)
- Electronic camming
- Fully-programmable feed & release settings
- Powered upper & lower feed rolls
- Durable cast frame construction
- Advanced monitoring diagnostics
- Push/pull configurations and DHS (3-axis) versions available for increased performance



	SR-150	SR-250
Material width (max)	150 mm	250 mm
Material thickness (max)	2.0 mm	3.0 mm
Feed roll width (std)	25 mm	50 mm
Feed roll width (max)	50 mm	150 mm
Indexes/min (max)	1500/min	1200/min

Control Options

Nidec Kyori Mitsubishi Platform Press Control

- Proven and robust control
- 10.4" touch panel SVGA
- Fully integrated Vamco SR series feed control
- Speed meter
- Electronic 9-digit total counter and preset counter
- Die height adjustment meter
- Tool parameter storage
- Periodic maintenance announcements
- Fault history
- Automatic control of heater /chiller unit
- UL compliant
- CE compliant
- Separate type operation panel

Nidec Kyori Siemens Platform Basic Press Control

- Developed to meet needs for European customer, CE compliant
- Based off proven functionality of Mitsubishi platform
- 12.1" touch panel SVGA
- Fully integrated Vamco SR series feed control
- Speed meter
- Electronic 9-digit total counter and preset counter
- Die height adjustment meter
- Tool parameter storage
- Periodic maintenance announcements
- Fault history
- Automatic control of heater / chiller unit
- Separate control cabinet and operator console
- Interconnect of die controller and oiler signals
- remote maintenance

NPA Siemens Platform European Press Control

- Newest, highest functioning press control to date
- Created specifically to place communication of specifications and customer support directly in Europe
- 15" touch IPC with ultra-high speed ethernet communication
- Decentralized peripherals with Profinet
- Siemens integrated safety circuit \ with Profinet
- Fully integrated Vamco SR series feed control
- Total counter and (8) preset counters
- Integrated 8 channel digital die protection
- Integrated 4 channel press force monitoring
- Die height adjustment meter
- Periodic maintenance announcements
- Fault history
- Automatic control of heater / chiller unit
- Separate control cabinet and operator console
- Interconnect of die controller and oiler signals
- remote maintenance

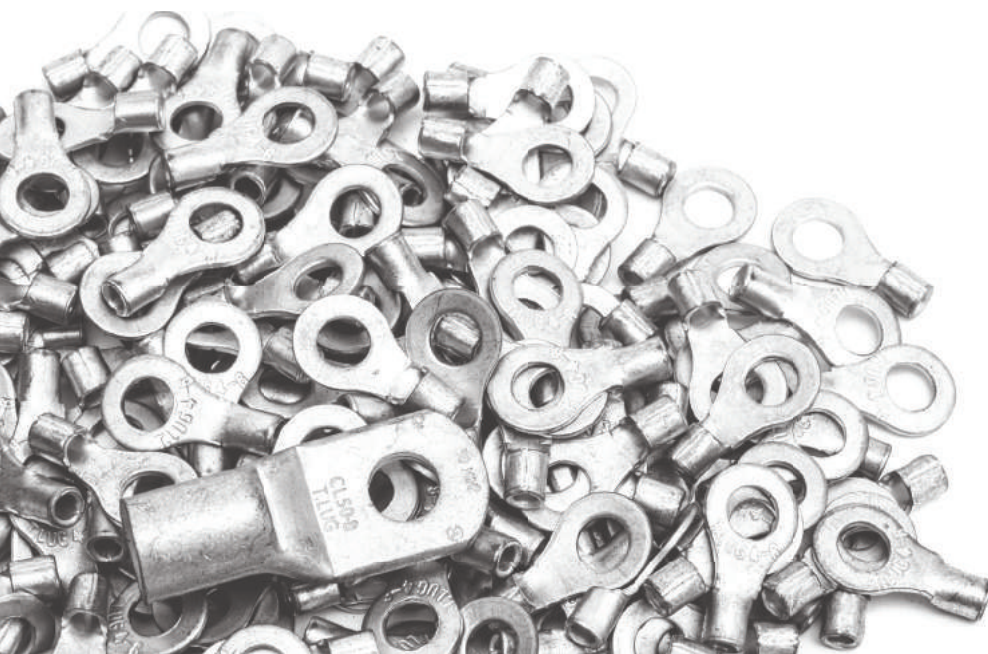

Specifications

		ANEX-15H	ANEX-30II	ANEX-40II	ANEX-40II W
Tons Capacity	kN	150	300	400	400
Stroke Length	mm	10	20/25/32	20/25/30/32	20/25/32/40
Strokes Per Minute	SPM	200-1800 (2000)	200-1200/1050/900	180- 1000/900/850/850	180- 850/800/700/700
Shutheight	mm	220	240	240	240/240/240/235
Shutheight Adjustment	mm	30	40	50	50/50/50/45
Slide Area	mm	500 x 260	600 x 300	750 x 340	950 x 450
Bolster Area	mm	500 x 360	600 x 400	750 x 500	950 x 600
Bolster Thickness	mm	80	90	120	120
Bed Opening	mm	350 x 50	400 x 100	560 x 120	790 x 120
Bolster Opening	mm	250 x 40	350 x 60	500 x 100	700 x 100
Main Motor	kw	15	11	15	18.5
Max. upper die weight	kg	60	80	105 / 105-155	150 / 150-180

ANEX-60II	ANEX-60II W	ANEX-80II	ANEX-80 W	ANEX-125	ANEX-150
600	600	800	800	1250	1500
20/25/32	25/32/40/45/50	20/25/32/36	25/32	25/36	25/36
100-750/750/650	100-700/600/450/400/350	120-700/600/550/500	120-500/450	100-400/350	100-400/250
300	340/340/335/325/320	320	320	350	350
80	80/80/75/65/60	80	80	80	80
1030 x 500	1280 x 500	1080 x 580	1380 x 580	1480 x 600	1480 x 600
1100 x 600	1350 x 600	1200 x 800	1500 x 800	1600 x 900	1600 x 900
140	140	160	160	180	180
840 x 120	1050 x 120	900 x 160	1200 x 160	1300 x 160	1300 x 160
780 x 80	1000 x 80	860 x 120	1160 x 120	1260 x 120	1260 x 120
22	22	30	30	37	37
450	500	500	500	600	900

Dimensions

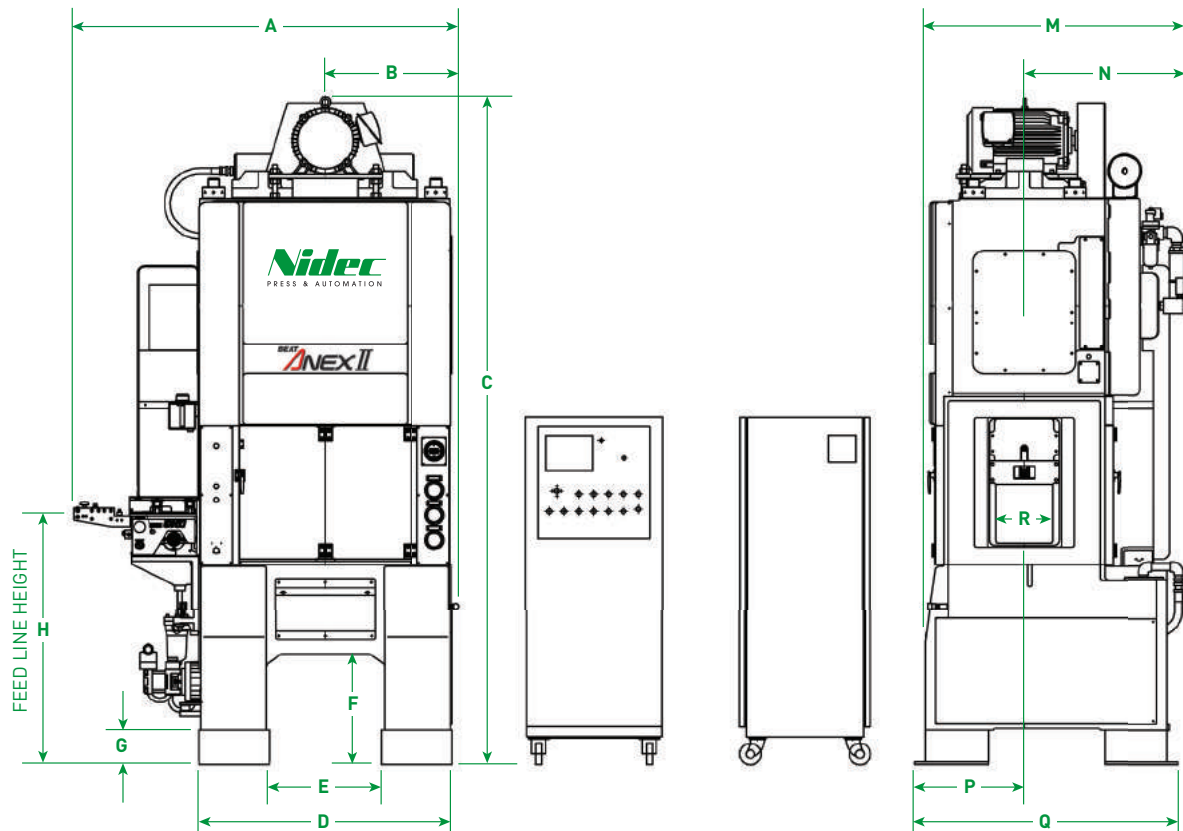

	ANEX-15H	ANEX-30II	ANEX-40II	ANEX-40II W	ANEX-60II
A	1510 mm	1780 mm	1850 mm	2050 mm	2840 mm
B	570 mm	610 mm	645 mm	745 mm	1420 mm
C	2820 mm	3075 mm	3180 mm	3185 mm	3080 mm
D	990 mm	1160 mm	1200 mm	1530 mm	1900 mm
E	420 mm	520 mm	530 mm	521 mm	900 mm
F	554 mm	530 mm	521 mm	521 mm	550 mm
G	164 mm	160 mm	161 mm	161 mm	150 mm
H	1074±20 mm	1120±20 mm	1191±20 mm	1191±20 mm	1240±20 mm
M	1240 mm	1315 mm	1300 mm	1330 mm	1490 mm
N	720 mm	780 mm	830 mm	830 mm	945 mm
P	450 mm	535 mm	520 mm	530 mm	705 mm
Q	1060 mm	1210 mm	1250 mm	1270 mm	1540 mm
R	140 mm	160 mm	200 mm	200 mm	230 mm

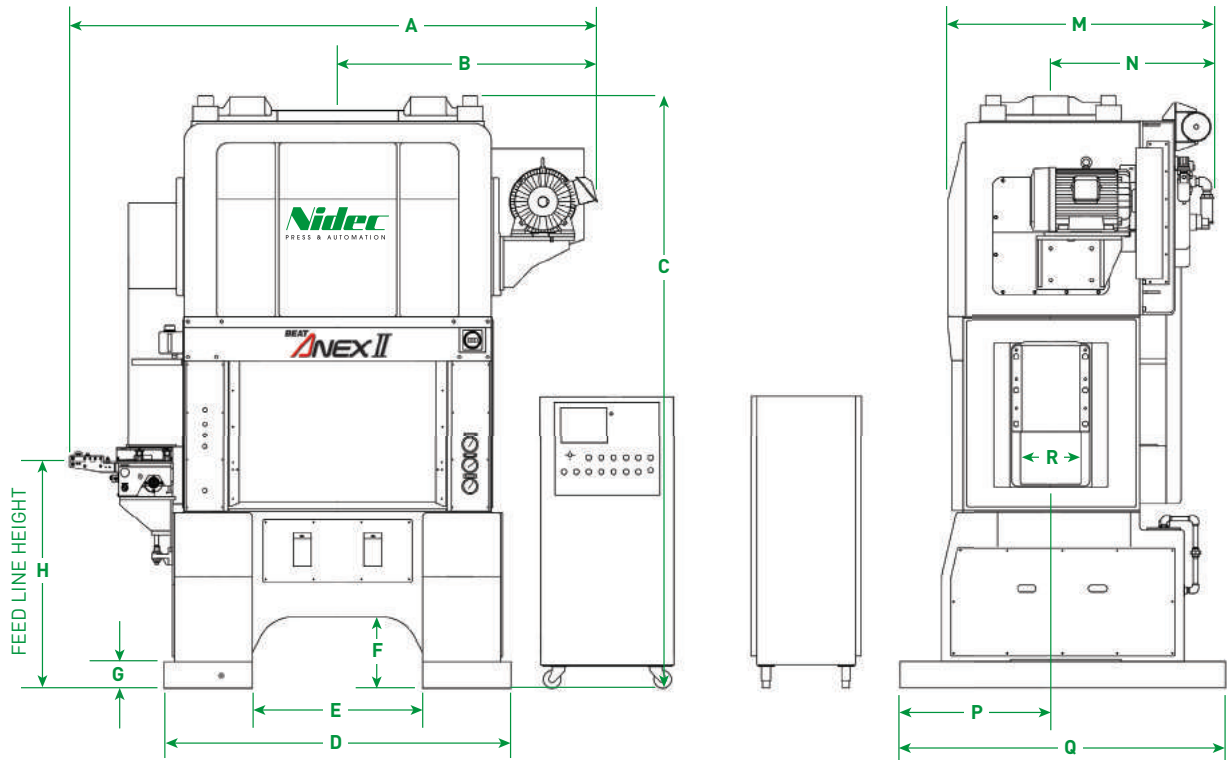

	ANEX-60II W	ANEX-80II	ANEX-80 W	ANEX-125	ANEX-150
A	3090 mm	3000 mm	3280 mm	3520 mm	3520 mm
B	1545 mm	1470 mm	1620 mm	1670 mm	1670 mm
C	3170 mm	3380 mm	3380 mm	4070 mm	4230 mm
D	2150 mm	1960 mm	2260 mm	2580 mm	2880 mm
E	1150 mm	960 mm	1260 mm	1320 mm	1320 mm
F	550 mm	400 mm	400 mm	515 mm	520 mm
G	150 mm	150 mm	150 mm	200 mm	205 mm
H	1240±20 mm	1280±20 mm	1280±20 mm	1630±20 mm	1635±20 mm
M	1490 mm	1555 mm	1560 mm	1730 mm	1730 mm
N	945 mm	970 mm	970 mm	1050 mm	1050 mm
P	705 mm	855 mm	820 mm	825 mm	935 mm
Q	1540 mm	1840 mm	1840 mm	1780 mm	2000 mm
R	230 mm	280 mm	280 mm	360 mm	360 mm





One Brand: A World of Resources

Nidec Press & Automation is the full service pressroom provider of choice for businesses in more than 90 countries and on six continents. Comprised of leading press room product brands, we ensure a complete offering of machinery, services and technology to meet your exact needs, enabling you to rely on one source.

Discover the freedom to achieve, to maximize and to drive your operation to exceed your goals. At Nidec Press & Automation, your success is the core of our focus and how we design our solutions to meet the rigid needs of the metal forming industry.

Choosing to work with us means you gain a constant resource with a global footprint, the brightest minds behind our solutions, and backed by regionally based OEM support ready to work as a natural extension of your team.

**Our promise to you is simple:
We're with you whenever and wherever
business takes you.**



MACHINERY

- Turn Key Systems
- Individual Components
- System/Tech Upgrades
- i4.0 Software Upgrades
- Integrated Controls

METAL FORMING PRESS APPLICATIONS

- Mechanical
- Servo
- Transfer
- High-Speed & Electrical
- Electrical Vehicle (EV)
- Lamination
- Container Cupping
- Container End-Conversion
- Container Shell
- Gap/ D-Frame

AUTOMATION

- Press Tending / Robotics
- Integrated Transfer Systems
- High Speed Servo Feeds
- High Speed Gripper Feeds
- Heavy-Duty Coil Lines

GLOBAL SERVICE NETWORK

- Field Service
- Emergency Response
- Technical Service & Support
- OEM Replacement Parts
- Machine & Component Remanufacturing
- Technical Training



61 Senthil Kumar Rd, Shasta layout, Rayasandra,
Bengaluru, Karnataka 560100
Ph : 9446643615, 9740984615

www.nemoinpresses.com - info@nemoinpresses.com

One Brand: A World of Resources

A single source solution that will help you find the efficiencies you want — all from the products, services and technology of Nidec Press & Automation.

nidecpa.com